

Register your instrument!
www.eppendorf.com/myeppendorf



Centrifuge 5427 R

Operating manual

Copyright © 2013 Eppendorf AG, Hamburg. No part of this publication may be reproduced without the prior permission of the copyright owner.

Trademarks

Eppendorf and the Eppendorf logo are registered trademarks of Eppendorf AG, Hamburg, Germany.

Microtainer is a registered trademark of Becton Dickinson, Franklin Lakes, NJ, USA.

Trademarks are not marked in all cases with TM or [®] in this manual.

Table of contents

1	Operating instructions	5
1.1	Using this manual	5
1.2	Danger symbols and danger levels	5
1.2.1	Danger symbols	5
1.2.2	Danger levels	5
1.3	Symbols used	5
1.4	Abbreviations used	6
2	Product description	7
2.1	Main illustration	7
2.2	Delivery package	8
2.3	Features	8
2.4	Rotors	9
2.4.1	Rotor FA-45-12-17	9
2.4.2	Rotor FA-45-24-11	10
2.4.3	Rotor FA-45-24-11-Kit	11
2.4.4	Rotors FA-45-30-11 and F-45-30-11	12
2.4.5	Rotors FA-45-48-11 and F-45-48-11	13
2.4.6	Rotor F-45-48-5-PCR	14
2.4.7	Rotor S-24-11-AT	14
3	Safety	15
3.1	Intended use	15
3.2	User profile	15
3.3	Application limits	15
3.3.1	Declaration concerning the ATEX directive (94/9/EC)	15
3.3.2	Maximum service life for accessories	15
3.4	Information on product liability	16
3.5	Warnings for intended use	17
3.5.1	Personal injury or damage to the equipment	17
3.5.2	Incorrect handling of the centrifuge	18
3.5.3	Incorrect handling of the rotors	18
3.5.4	Extreme strain on the centrifuging tubes	19
3.5.5	Aerosol-tight centrifugation	20
3.6	Safety instructions located on the device	20
4	Installation	21
4.1	Selecting the location	21
4.2	Preparing installation	21
4.3	Installing the instrument	22
5	Operation	23
5.1	Overview of operating controls	23
5.2	Menu navigation	25
5.3	Menu	25
5.4	Preparing for centrifugation	27
5.4.1	Switching on the centrifuge	27
5.4.2	Inserting the rotor	27
5.4.3	Automatic rotor detection	27
5.4.4	Replacing the rotor	27
5.4.5	Loading the rotor	28
5.4.6	Closing the rotor lid	30
5.4.7	Closing the centrifuge lid	30

Table of contentsCentrifuge 5427 R
English (EN)

5.5	Cooling	30
5.5.1	Set the temperature	30
5.5.2	Temperature display	30
5.5.3	Temperature monitoring	31
5.5.4	Start FastTemp	31
5.5.5	Continuous cooling	32
5.5.6	Endless operation of continuous cooling	32
5.6	Centrifuging	33
5.6.1	Centrifuging with preset time	33
5.6.2	Centrifuging in continuous operation	34
5.6.3	Short spin centrifugation	34
5.6.4	Setting the centrifugation radius	35
5.6.5	After centrifugation	35
5.7	Standby mode	35
6	Maintenance	37
6.1	Prepare cleaning/disinfection	37
6.2	Cleaning/disinfection	37
6.2.1	Cleaning and disinfecting the device	38
6.2.2	Cleaning and disinfecting the rotor	38
6.3	Additional service instructions for Centrifuge 5427 R	39
6.4	Glass breakage	39
6.5	Replacing fuses	40
6.6	Decontamination before shipment	40
7	Troubleshooting	41
7.1	General errors	41
7.2	Error messages	42
7.3	Emergency release	44
8	Transport, storage and disposal	45
8.1	Transport	45
8.2	Storage	45
8.3	Disposal	45
9	Technical data	47
9.1	Power supply	47
9.2	Ambient conditions	47
9.3	Weight/dimensions	47
9.4	Application parameters	48
9.5	Acceleration times and deceleration times for the Centrifuge 5427 R (according to DIN 58 970)	49
10	Ordering Information	51
10.1	Centrifuge 5427 R	51
10.2	Accessories	51
10.2.1	Rotors and rotor lids	51
10.2.2	Adapters	52
10.2.3	Other accessories	53
10.3	Safety	53

1 Operating instructions







1.1 Using this manual

- ▶ Read this operating manual completely before using the device for the first time. Please also note the operating instructions for the accessories, if applicable.
- ▶ This operating manual is part of the product. Thus, it must always be easily accessible.
- ▶ Enclose this operating manual when transferring the device to third parties.
- ▶ If this manual is lost, please request another one. You will find the current version on our webpage www.eppendorf.com.

1.2 Danger symbols and danger levels

The safety instructions in this manual appear with the following danger symbols and danger levels:

1.2.1 Danger symbols

	Biohazard		Explosion
	Electric shock		Crushing
	Hazard point		Material damage

1.2.2 Danger levels

DANGER	<i>Will</i> lead to severe injuries or death.
WARNING	<i>Can</i> lead to severe injuries or death.
CAUTION	Can lead to light to moderate injuries.
ATTENTION	May lead to material damage./Paragraph

1.3 Symbols used

Depiction	Meaning
1. 2.	Actions in the specified order
▶	Actions without a specified order
•	List:
<i>Text</i>	Display or software texts
	Additional information

Operating instructions

Centrifuge 5427 R
English (EN)

1.4 Abbreviations used**NN**

Mean sea level (MSL)

PCR

Polymerase chain reaction

RZB/rcf

Relative centrifugal force – *g*-force in m/s^2

rpm

Revolutions per minute – in rpm

UV

Ultraviolet radiation

2 Product description

2.1 Main illustration

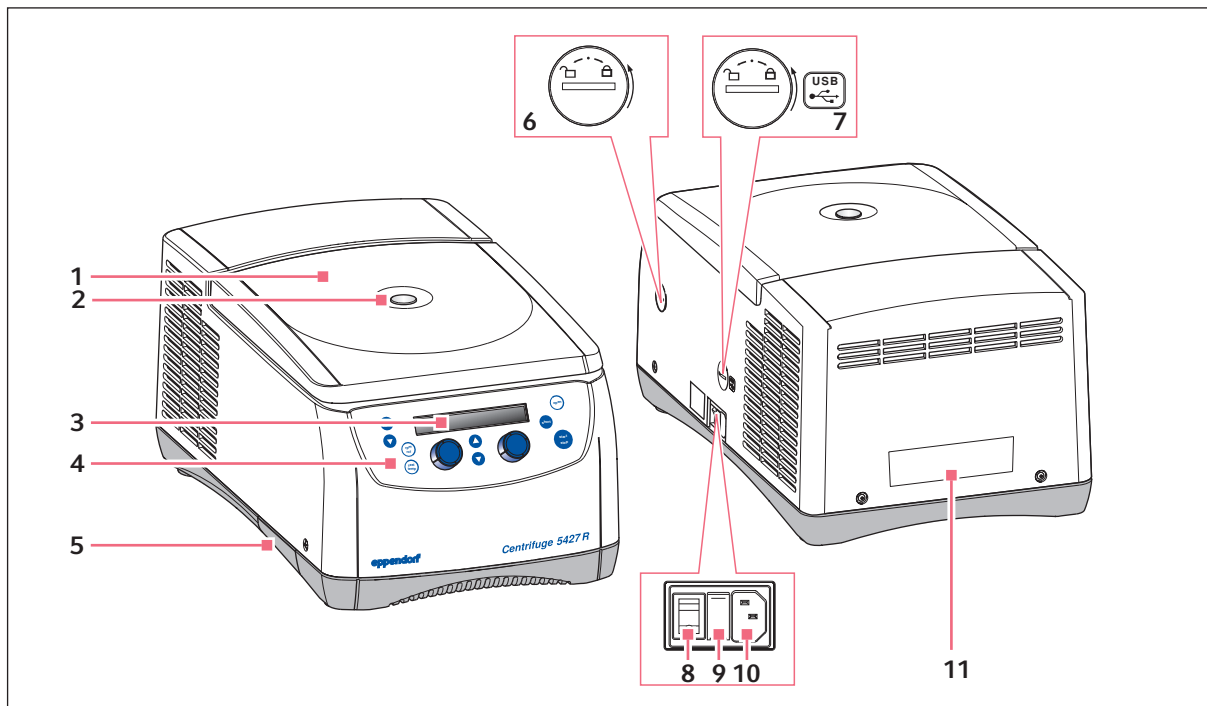

Fig. 2-1: Front and rear view of the Centrifuge 5427 R

1 Centrifuge lid

2 Monitoring glass

Visual control for rotor stop or speed control option using stroboscope

3 Display

Display of centrifugation parameters and device settings (see Fig. 5-2 on p. 24)

4 Control panel

Keys and dials for operating centrifuge (see Fig. 5-1 on p. 23)

5 Condensation water tray (only)

6 Emergency release

(see p. 44)

7 USB port

Only for Technical Service: interfaces for error analyses and software updates

8 Mains/power switch

Switch for switching the device on (I) and off (O)

9 Fuse holder

10 Power connection socket

Connection for supplied power cable

11 Name plate

Product description

Centrifuge 5427 R
English (EN)

2.2 Delivery package

Quantity	Order no. (International)	Order no. (North America)	Description
1	-	-	Centrifuge 5427 R See chapter <i>Ordering Information</i> for corresponding device version, equipment and order number
1 or or	5301 850.249 5427 850.341 5811 352.006	022654403 022654381 022664107	Fuse 4.0 A (230 V), 2 pieces 8.0 AT UL (120 V), 2 pieces 10.0 AT UL (100 V), 2 pieces
1	5416 301.001	022634305	Rotor key Standard
1	-	-	Mains power cable
1	5409 850.083		Tray for condensation water
1	5409 900.021	5409900021	Operating Manual Centrifuge 5427 R Languages: EN, DE, FR, ES, IT, PT
1	5409 900.030	5409900030	Languages: DA, FI, EL, NL, SV (only 230 V devices)

2.3 Features

The high-performance Centrifuge 5427 R has a capacity of 48 × 2 mL and maximally reaches 25 001 × *g* resp. maximally 16 220 rpm. You can select from 9 different rotors to centrifuge the following tubes for your various applications:

- Tubes (0.2 mL to 5.0 mL)
- PCR strips
- Microtainers (0.6 ml)
- Spin columns (1.5 mL, 2.0 mL)

The Centrifuge 5427 R has a temperature function for centrifugation at temperatures of -11 °C to 40 °C. The **FastTemp** function is used to start a temperature control run without samples in order to quickly bring the rotor chamber to the set temperature.

2.4 Rotors





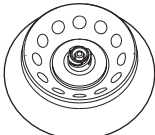

Eppendorf centrifuges may only be operated with rotors that are intended for use with the corresponding centrifuge.

- ▶ Only use rotors which are marked with the name of the centrifuge (e.g., 5427 R).

2.4.1 Rotor FA-45-12-17









	Rotor FA-45-12-17 Aerosol-tight fixed-angle rotor for 12 reaction tubes	Max. <i>g</i> -force:	20 598 × <i>g</i>
		Max. speed:	14 000 rpm
		Max. load (adapter, tube and contents):	12 × 9.5 g

Vessels	Vessel Capacity Vessels per adapter/rotor	Adapters Order no. (international)	Adapter base Tube diameter	Max. <i>g</i> -force: Max. speed Centrifugation radius
	Vessel 5 mL -/12	–	– Ø 17 mm	20 598 × <i>g</i> 14 000 rpm 9.4 cm
	Vessel 1.5 mL/2.0 mL 1/12	 5820 768.002	open Ø 11 mm	17 530 × <i>g</i> 14 000 rpm 8.0 cm
	HPLC vessel 1/12	 5820 770.007	flat Ø 11 mm	16 215 × <i>g</i> 14 000 rpm 7.4 cm
	Cryo tube 1.0 mL – 2.0 mL 1/12	 5820 769.009	flat Ø 13 mm	18 188 × <i>g</i> 14 000 rpm 8.3 cm

Product descriptionCentrifuge 5427 R
English (EN)







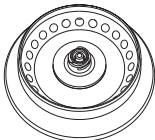

2.4.2 Rotor FA-45-24-11

	Rotor FA-45-24-11 Aerosol-tight fixed-angle rotor for 24 tubes	Max. <i>g</i> -force:	25 001 × <i>g</i>
		Max. speed:	16 220 rpm
		Max. load (adapter, tube and contents):	24 × 3.75 <i>g</i>

Vessels	Vessel Capacity Vessels per adapter/rotor	Adapters Order no. (international)	Adapter base Tube diameter	Max. <i>g</i> -force: Max. speed Centrifugation radius
	Vessel 1.5 mL/2.0 mL -/24	–	– Ø 11 mm	25 001 × <i>g</i> 16 220 rpm 8.5 cm
	PCR tube 0.2 mL 1/24	 5425 715.005	conical Ø 6 mm	18 825 × <i>g</i> 16 220 rpm 6.4 cm
	Vessel 0.4 mL 1/24	 5425 717.008	conical Ø 6 mm	25 001 × <i>g</i> 16 220 rpm 8.5 cm
	Vessel 0.5 mL 1/24	 5425 716.001	open Ø 8 mm	21 766 × <i>g</i> 16 220 rpm 7.4 cm
	Microtainers 0.6 mL 1/24	 5425 716.001	open Ø 8 mm	25 001 × <i>g</i> 16 220 rpm 8.5 cm

2.4.3 Rotor FA-45-24-11-Kit







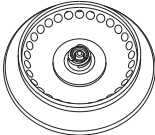

	Rotor FA-45-24-11-Kit Aerosol-tight fixed-angle rotor for 24 tubes	Max. <i>g</i> -force:	19 090 × <i>g</i>
		Max. speed:	13 200 rpm
		Max. load (adapter, tube and contents):	24 × 3.75 <i>g</i>

Vessels	Vessel Capacity Vessels per adapter/rotor	Adapters Order no. (international)	Adapter base Tube diameter	Max. <i>g</i> -force: Max. speed Centrifugation radius
	Vessel 1.5 mL/2.0 mL -/24	–	– Ø 11 mm	19 090 × <i>g</i> 13 200 rpm 9.8 cm
	PCR tube 0.2 mL 1/24	 5425 715.005	conical Ø 6 mm	15 000 × <i>g</i> 13 200 rpm 7.7 cm
	Vessel 0.4 mL 1/24	 5425 717.008	conical Ø 6 mm	19 090 × <i>g</i> 13 200 rpm 9.8 cm
	Vessel 0.5 mL 1/24	 5425 716.001	open Ø 8 mm	16 948 × <i>g</i> 13 200 rpm 8.7 cm
	Microtainers 0.6 mL 1/24	 5425 716.001	open Ø 8 mm	19 090 × <i>g</i> 13 200 rpm 9.8 cm

Product descriptionCentrifuge 5427 R
English (EN)







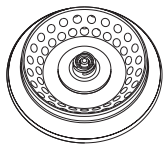

2.4.4 Rotors FA-45-30-11 and F-45-30-11

	Rotor FA-45-30-11	Max. <i>g</i> -force:	20 817 × <i>g</i>
	Aerosol-tight fixed-angle rotor for 30 tubes	Max. speed:	14 000 rpm
	Rotor F-45-30-11	Max. load (adapter, tube and contents):	30 × 3.75 g
	Fixed-angle rotor for 30 tubes		

Vessels	Vessel Capacity Vessels per adapter/rotor	Adapters Order no. (international)	Adapter base Tube diameter	Max. <i>g</i> -force: Max. speed Centrifugation radius
	Vessel 1.5 mL/2.0 mL -/30	–	– Ø 11 mm	20 817 × <i>g</i> 14 000 rpm 9.5 cm
	PCR tube 0.2 mL 1/30	 5425 715.005	conical Ø 6 mm	16 215 × <i>g</i> 14 000 rpm 7.4 cm
	Vessel 0.4 mL 1/30	 5425 717.008	conical Ø 6 mm	20 817 × <i>g</i> 14 000 rpm 9.5 cm
	Vessel 0.5 mL 1/30	 5425 716.001	open Ø 8 mm	18 407 × <i>g</i> 14 000 rpm 8.4 cm
	Microtainers 0.6 mL 1/30	 5425 716.001	open Ø 8 mm	20 817 × <i>g</i> 14 000 rpm 9.5 cm

2.4.5 Rotors FA-45-48-11 and F-45-48-11



	FA-45-48-11 rotor Aerosol-tight fixed-angle rotor for 48 tubes	Max. <i>g</i> -force: 18 213 × <i>g</i> (outer ring) 16 049 × <i>g</i> (inner ring)
	Rotor F-45-48-11 Fixed-angle rotor for 48 tubes	Max. speed: 12 700 rpm
	Max. load (adapter, tube and contents):	48 × 3.75 g

Vessels	Vessel	Adapters	Adapter base	Max. <i>g</i> -force: Outer ring Inner ring
	Capacity	Order no. (international)	Tube diameter	Max. speed
	Vessels per adapter/rotor			Centrifugation radius Outer ring Inner ring
	Vessel 1.5 mL/2.0 mL -/48	–	– Ø 11 mm	18 213 × <i>g</i> 16 049 × <i>g</i> 12 700 rpm 10.1 cm 8.9 cm
	PCR tube 0.2 mL 1/48	 5425 715.005	conical Ø 6 mm	14 426 × <i>g</i> 12 262 × <i>g</i> 12 700 rpm 8 cm 6.8 cm
	Vessel 0.4 mL 1/48	 5425 717.008	conical Ø 6 mm	18 213 × <i>g</i> 16 049 × <i>g</i> 12 700 rpm 10.1 cm 8.9 cm
	Vessel 0.5 mL 1/48	 5425 716.001	open Ø 8 mm	16 229 × <i>g</i> 14 065 × <i>g</i> 12 700 rpm 9 cm 7.8 cm
	Microtainers 0.6 mL 1/48	 5425 716.001	open Ø 8 mm	18 213 × <i>g</i> 16 049 × <i>g</i> 12 700 rpm 10.1 cm 8.9 cm

Product descriptionCentrifuge 5427 R
English (EN)

2.4.6 Rotor F-45-48-5-PCR

	Rotor F-45-48-5-PCR Fixed-angle rotor for 48 PCR tubes	Max. <i>g</i> -force:	11 710 × <i>g</i>
		Max. speed:	10 500 rpm
		Max. load (tube and contents):	48 × 0.43 g

Tubes	Tube Capacity Tubes per adapter/ rotor	Adapter	Adapter base Tube diameter	Max. <i>g</i> -force: Max. speed Centrifugation radius
	0.2 mL -/48	–	conical Ø 6 mm	11 710 × <i>g</i> 10 500 rpm 9.5 cm
	PCR strips 0.2 mL -/6 × 8	–	conical Ø 6 mm	11 710 × <i>g</i> 10 500 rpm 9.5 cm

2.4.7 Rotor S-24-11-AT

This rotor is only intended for use with 1.5 mL/2.0 mL tubes.

The following tubes must not be used in this rotor:

- Adapters for 0.2 mL, 0.4 mL, 0.5 mL and 0.6 mL tubes and the corresponding tubes.
- Spin columns

	Rotor S-24-11-AT Bucket for tubes: 4 × 1.5 mL/2.0 mL	Max. <i>g</i> -force:	16 049 × <i>g</i>
		Max. speed:	12 700 rpm
		Max. load per bucket (tube and contents):	4 × 3.75 g

Vessels	Vessel Capacity Vessels per adapter/rotor	Adapters Order no. (international)	Adapter base Tube diameter	Max. <i>g</i> -force: Max. speed Centrifugation radius
	Vessel 1.5 mL/2.0 mL -/24	–	– Ø 11 mm	16 049 × <i>g</i> 12 700 rpm 8.9 cm

3 Safety

3.1 Intended use

The Centrifuge 5427 R is intended exclusively for indoor use and for separating aqueous solutions and suspensions of various densities in approved test tubes.

3.2 User profile

This device may only be operated by trained specialist staff. They must have carefully read the operating manual and be familiar with the function of the device.

3.3 Application limits

3.3.1 Declaration concerning the ATEX directive (94/9/EC)



DANGER! Risk of explosion.

- ▶ Do not operate the device in areas where work is completed with explosive substances.
 - ▶ Do not use this device to process any explosive or highly reactive substances.
 - ▶ Do not use this device to process any substances which may generate an explosive atmosphere.
-

Due to its design and the environmental conditions inside the device, the Centrifuge 5427 R is not suitable for use in a potentially explosive atmosphere.

The device only must be used in a safe environment, such as the open environment of a ventilated laboratory or fume hood. The use of substances which could create a potentially explosive atmosphere is not permitted. The final decision on the risks associated with the use of these types of substances is the responsibility of the user.

3.3.2 Maximum service life for accessories



WARNING! Risk of injury from chemically or mechanically damaged accessories.

Even minor scratches and cracks can lead to serious internal material damage.

- ▶ Protect all accessory parts from mechanical damage.
 - ▶ Inspect the accessories for damage before each use. Replace any damaged accessories.
 - ▶ Do not use rotors, rotor lids or buckets with signs of corrosion or mechanical damage (e.g., deformations).
 - ▶ Do not use any accessories whose maximum service life has been exceeded.
-



CAUTION! Risk of injury due to chemically damaged rotor lids or caps.

Transparent rotor lids or caps made from PC, PP or PEI may lose their strength under the impact of organic solvents (e.g., phenol, chloroform).

- ▶ If rotor lids or caps have come into contact with organic solvents, they should be cleaned immediately.
 - ▶ Regularly check the rotor lids and caps for damages and cracks.
 - ▶ Immediately replace rotor lids or caps that have cracks or milky stains.
-

Safety

Centrifuge 5427 R
English (EN)

Beginning with the first commissioning, the following rotors including the corresponding buckets, carriers and rotor lids have a maximum service life of 7 years or of the number of cycles specified in the table (depending on what occurs first).

Rotor/accessories	Maximum service from commissioning onward	
S-24-11-AT (5427 R/5430/5430 R)	100,000 cycles	7 years
FA-45-48-11 (5427 R/5430/5430 R/5804/5804 R/5810/5810 R)	100,000 cycles	7 years
FA-45-12-17 (Centrifuge 5427 R)	100,000 cycles	7 years
QuickLock rotor lid		3 years
Seals of the QuickLock rotor lid	50 autoclaving cycles	–
Rotor lid or caps made of polycarbonate (PC), polypropylene (PP) or polyetherimide (PEI)	50 autoclaving cycles	3 years
Adapter	–	1 year

For all other rotors and rotor lids of this centrifuge there is no service life limit as long as the following requirements are met:

- Proper use,
- Recommended maintenance
- Undamaged condition

The date of manufacture is stamped on the rotors in the format *03/10* (= March 2010) or on the inside of the plastic rotor lids in the form of a clock ⌚.

To ensure aerosol tightness, the following applies:

- Replace aerosol-tight rotor lids and caps after 50 autoclaving cycles.
- Replace the seal of QuickLock rotor lids after 50 autoclaving cycles.

3.4 Information on product liability

In the following cases, the designated protection of the device may be compromised. Liability for any resulting property damage or personal injury is then transferred to the operator:

- The device is not used in accordance with the operating manual.
- The device is used outside of its intended use.
- The device is used with accessories or consumables which are not recommended by Eppendorf.
- The device is maintained or repaired by people not authorized by Eppendorf.
- The user makes unauthorized changes to the device.

3.5 Warnings for intended use

Read the operating manual and observe the following general safety instructions before using the Centrifuge 5427 R.

3.5.1 Personal injury or damage to the equipment



WARNING! Electric shock due to damage to device or mains cable.

- ▶ Only switch on the device if the device and mains cable are undamaged.
- ▶ Only use devices that have been properly installed or repaired.
- ▶ In case of danger, disconnect the device from the mains supply by pulling the power plug from the device or the mains socket or, by using the isolating device intended for this purpose (e.g. emergency stop switch in the laboratory).



WARNING! Lethal voltages inside the device.

- ▶ Ensure that the housing is always closed and undamaged so that no parts inside the device can be contacted by accident.
- ▶ Do not remove the housing of the device.
- ▶ Do not allow any liquids to penetrate the inside of the housing.
- ▶ Do not allow the device to be opened by anyone except service personnel who have been specifically authorized by Eppendorf.



WARNING! Risk from incorrect supply voltage

- ▶ Only connect the device to voltage sources which correspond to the electrical requirements on the name plate.
- ▶ Only use sockets with a protective earth (PE) conductor and suitable power cable.



WARNING! Damage to health due to infectious liquids and pathogenic germs.

- ▶ When handling infectious liquids and pathogenic germs, observe the national regulations, the biological security level of your laboratory, the material safety data sheets, and the manufacturer's application notes.
- ▶ Use aerosol tight sealing systems for the centrifugation of these substances.
- ▶ When working with pathogenic germs belonging to a higher risk group, more than one aerosol-tight bioseal must be used.
- ▶ Wear personal protective equipment.
- ▶ For full instructions regarding the handling of germs or biological material of risk group II or higher, please refer to the "Laboratory Biosafety Manual" (Source: World Health Organization, current edition of the Laboratory Biosafety Manual).



WARNING! Risk of injury when opening or closing the centrifuge lid.

There is a risk of crushing your fingers when opening or closing the centrifuge lid.

- ▶ When opening or closing the centrifuge lid, do not reach between the lid and device or into the latching mechanism of the lid.
- ▶ Always open the centrifuge lid completely to prevent it from falling.



CAUTION! Poor safety due to incorrect accessories and spare parts.

The use of accessories and spare parts other than those recommended by Eppendorf may impair the safety, functioning and precision of the device. Eppendorf cannot be held liable or accept any liability for damage resulting from the use of incorrect or non-recommended accessories and spare parts, or from the improper use of such equipment.

- ▶ Only use accessories and original spare parts recommended by Eppendorf.



NOTICE! Damage to device due to spilled liquids.

1. Switch off the device.
2. Disconnect the device from the power supply.
3. Carefully clean the device and the accessories in accordance with the cleaning and disinfection instructions in the operating manual.
4. If a different cleaning and disinfecting method is to be used, contact Eppendorf AG to ensure that the intended method will not damage the device.



NOTICE! Damage to electronic components due to condensation.

Condensate can form in the device after it has been moved from a cool environment to a warmer environment.

- ▶ After installing the device, wait for at least 4 h. Only then connect the device to the mains power supply.

3.5.2 Incorrect handling of the centrifuge



NOTICE! Damage from knocking against or moving the device during operation.

If the rotor bangs against the rotor chamber wall, it will cause considerable damage to the device and rotor.

- ▶ Do not move or knock against the device during operation.

3.5.3 Incorrect handling of the rotors



WARNING! Risk of injury from improperly attached rotors and rotor lids.

- ▶ Only centrifuge with rotor and rotor lid firmly tightened.
- ▶ If unusual noises occur when the centrifuge starts, the rotor or the rotor lid may not be properly secured. Immediately press the **start/stop** key to stop centrifuging.



CAUTION! Risk of injury due to asymmetric loading of a rotor.

- ▶ Load rotors symmetrically with identical tubes.
- ▶ Only load adapters with suitable tubes.
- ▶ Always use the same type of tubes (weight, material/density and volume).
- ▶ Check symmetric loading by balancing the adapters and tubes used with scales.



CAUTION! Risk of injury from overloaded rotor.

The Centrifuge 5427 R is designed for the centrifugation of material with a max. density of 1.2 g/mL at maximum speed and filling volume and/or load.

- ▶ Do not exceed the maximum load of the rotor.



NOTICE! Damage to rotors from aggressive chemicals.

Rotors are high-quality components which withstand extreme stresses. This stability can be impaired by aggressive chemicals.

- ▶ Avoid using aggressive chemicals, including strong and weak alkalis, strong acids, solutions with mercury, copper and other heavy metal ions, halogenated hydrocarbons, concentrated saline solutions and phenol.
- ▶ Due to the manufacturing process, color variations may occur on rotors marked "coated". These color variations do not effect service life or resistance to chemicals.



NOTICE! If handled incorrectly, the rotor can fall over.

The rotor can fall over if the buckets are used as a handle.

- ▶ Remove the buckets before inserting and/or removing a swing-bucket rotor.
- ▶ Always use both hands to carry the rotor cross.

3.5.4 Extreme strain on the centrifuging tubes



CAUTION! Risk of injury from overloaded tubes.

- ▶ Note the loading limits specified by the tube manufacturer.
- ▶ Only use tubes which are approved by the manufacturer for the required rcf.



NOTICE! Risk from damaged tubes.

Damaged tubes must not be used, as this could cause further damage to the device and the accessories and loss of the samples.

- ▶ Before use, visually check all of the tubes for damage.



NOTICE! Risk from open tube lids.

Open tube lids can brake off during centrifugation and damage the rotor and the centrifuge.

- ▶ Carefully seal all tube lids before centrifuging.

Exception: Note the information on the centrifugation of spin columns in the rotor FA-45-24-11-Kit (see *Preparing for centrifugation on p. 27*).



NOTICE! Hazard to plastic tubes from organic solvents.

The density of plastic tubes is reduced when organic solvents (e.g., phenol, chloroform) are used, i.e. the tubes could become damaged.

- ▶ Observe the manufacturer's specifications for chemical resistance of the tubes.

3.5.5 Aerosol-tight centrifugation



WARNING! Risk to health due to limited aerosol tightness with incorrect rotor/rotor lid combination.

Aerosol-tight centrifugation is guaranteed only if the rotors and rotor lids intended for this purpose are used. The designation of aerosol-tight fixed-angle rotors always starts with **FA**. The aerosol-tight rotors and rotor lids of this centrifuge are additionally marked with a red ring on the rotor and a red rotor lid screw.

Aerosol-tight swing-bucket rotors are marked with **AT** (aerosol-tight).

- ▶ For aerosol-tight centrifugation, always simultaneously use rotors and rotor lids which are marked as aerosol-tight in the centrifuge intended for the corresponding purpose. The details specifying in which centrifuge you may use the aerosol-tight rotors and rotor lids can be found on the rotor and, beginning from production date of October 2003, on the upper side of the rotor lid.
- ▶ Only use aerosol-tight rotor lids in combination with rotors which are marked on the rotor lid.



WARNING! Damage to health as a result of limited aerosol tightness and incorrect usage.

Autoclaving, mechanical stresses and contamination by chemicals or other aggressive solvents can impair the aerosol-tightness of the rotors and rotor lids.

- ▶ Check the integrity of the seals of the aerosol-tight rotor lids or caps before each use.
- ▶ Only use aerosol-tight rotor lids or caps if the seals are undamaged and clean.
- ▶ Lightly grease the threads of the rotor lid screw with pivot grease after every proper autoclaving (121 °C, 20 min.) (int. order no. Int. 5810 350.050, North America 022634330).
- ▶ Replace aerosol-tight rotor lids and caps after 50 autoclaving cycles.
- ▶ For QuickLock rotor lids, the seal must be replaced after 50 autoclaving cycles.
- ▶ **Never** store aerosol-tight rotors or buckets closed.

3.6 Safety instructions located on the device

Display	Meaning	Location
	Hazard point	Right side of the device
	CAUTION Always tighten the rotor using the supplied rotor key.	Top of device, below the centrifuge lid
	CAUTION Close all tubes and use a rotor lid.	Top of device, below the centrifuge lid
	Warning of biological risks when handling infectious liquids or pathogenic germs.	Aerosol-tight rotors/rotor lids, aerosol-tight buckets/caps.

4 Installation

4.1 Selecting the location



NOTICE! If an error occurs, the objects in the immediate proximity of the device will be damaged.

- ▶ In accordance with recommendations in EN 61010-2-020, leave a safety clearance of **30 cm** around the device during operation.
- ▶ Please remove all materials and objects from this area.



NOTICE! Damage from overheating.

- ▶ Do not install the device near heat sources (e.g. heating, drying cabinet).
 - ▶ Do not expose the device to direct sunlight.
 - ▶ Ensure unobstructed air circulation. Maintain a clearance of at least 30 cm (11.8 in) around all ventilation grilles.
-

Select the location for the device according to the following criteria:

- Suitable power connection as per the name plate (230 V/120 V/100 V).
- Stable, horizontal and resonance-free lab bench.
- A well ventilated environment which is protected from direct sunlight to prevent the device from heating up more.

4.2 Preparing installation

Prerequisites

The weight of the centrifuge is 30.0 kg (66.14 lb). For unpacking and installation the assistance of another person is required.

Perform the following steps in the sequence described.

1. Open the box.
2. Remove the accessories.
3. The centrifuge must be lifted from the box by two people.
4. Remove the transport securing device from the sides.
5. Place the device on a suitable lab bench.



Do not use the opening for the condensation water tray as a handle.

6. Remove the plastic sleeve.

4.3 Installing the instrument

Prerequisites

The device is on a suitable lab bench.



NOTICE! Damage to electronic components due to condensation.

Condensate can form in the device after it has been moved from a cool environment to a warmer environment.

- ▶ After installing the device, wait for at least 4 h. Only then connect the device to the mains power supply.



NOTICE! Centrifuge 5427 R: compressor damage after improper transport.

- ▶ Only switch on the centrifuge 4 h after installation.

Perform the following steps in the sequence described.

1. Let the device warm up to ambient temperature.
2. Check that the mains voltage and frequency match the requirements on the device type plate.
3. Connect the centrifuge to the mains and switch it on using the mains/power switch.
 - Display is active.
 - Lid opens automatically
4. Remove the transport securing device of the lid latch.
5. Remove the transport securing device of the motor shaft.
6. Use the details included in the scope of delivery to check that the delivery is complete.
7. Check all parts for any transport damage. Contact your dealer if any damage is found.
8. Insert the condensation water tray into the holder provided (see Fig. 2-1 on p. 7).



Retain the packaging material and the transport protection device for subsequent transport or storage. See also the instructions relating to transport (see p. 45).

5 Operation

5.1 Overview of operating controls

Before using the Centrifuge 5427 R, familiarize yourself with the display and operating controls.

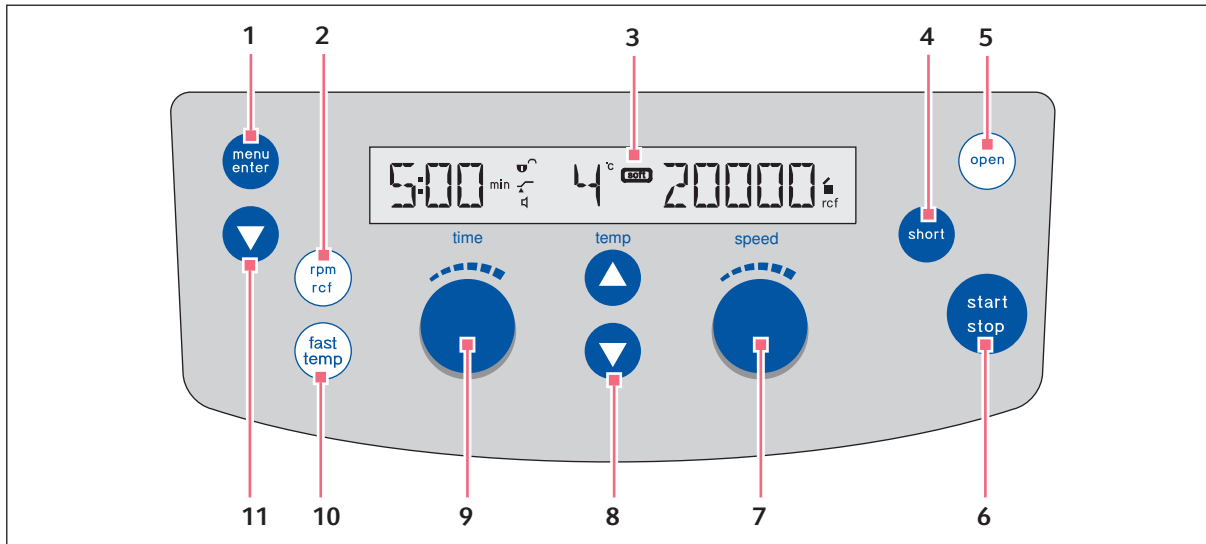

Fig. 5-1: Operator panel of the Centrifuge 5427 R

- | | |
|---|--|
| 1 Call and select the menu parameters
(see <i>Menu navigation</i> on p. 25) | 7 Set speed of centrifugation |
| 2 Switch display of centrifugation speed (rpm or rcf) | 8 Set temperature |
| 3 Display | 9 Set centrifugation time |
| 4 Short spin centrifugation
(see <i>Short spin centrifugation</i> on p. 34) | 10 Start FastTemp temperature control run
(see <i>Start FastTemp</i> on p. 31) |
| 5 Release lid | 11 Select menu item
(see <i>Menu navigation</i> on p. 25) |
| 6 Start and stop centrifugation | |

Please also read the precise description of the individual menu functions (see p. 25).

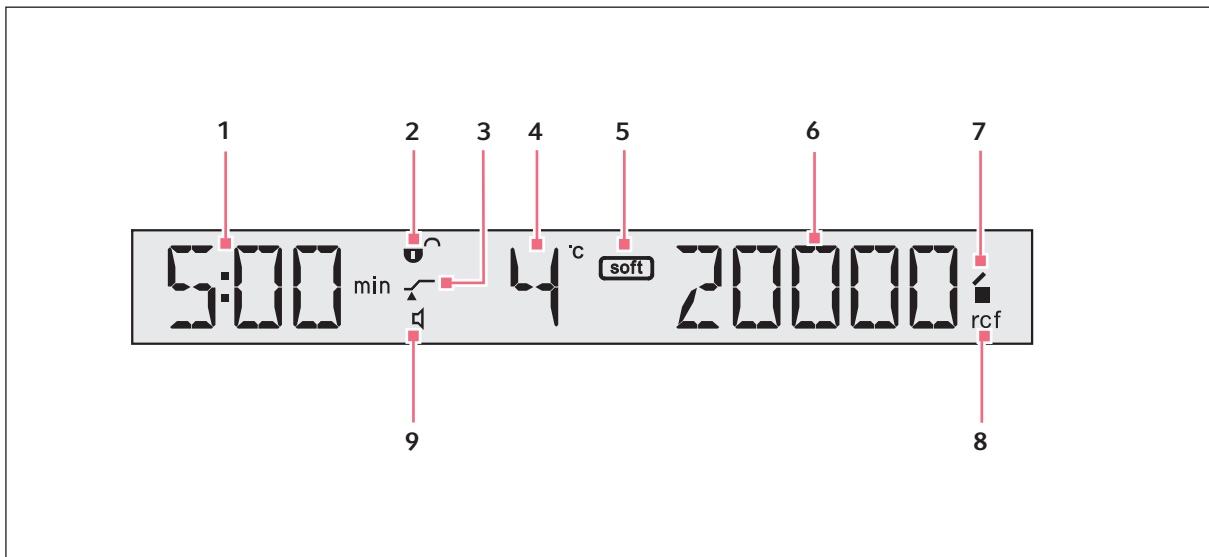







Fig. 5-2: Display of the Centrifuge 5427 R.

- | | |
|---|--|
| <p>1 Centrifugation time</p> <p>2 Key lock
 Key lock. Centrifugation parameters cannot be accidentally changed.
 No key lock. Centrifugation parameters can be changed.</p> <p>3 Start of run time: ATSET function
 Start of run time after reaching 95 % of the specified <i>g</i>-force (rcf) or speed (rpm).
 Immediate start of run time.</p> <p>4 Temperature</p> <p>5 Soft ramp
 Rotor accelerates and brakes slowly.
 No symbol: fast acceleration and braking of rotor.</p> | <p>6 <i>g</i>-force (rcf) or speed (rpm)
 (see <i>Rotors on p. 9</i>)</p> <p>7 Status of centrifuge
 Centrifuge lid unlocked.
 Centrifuge lid locked.
 (Flashing): Centrifuging in progress.</p> <p>8 Display of centrifugation speed
 rcf <i>g</i>-force (relative centrifugal acceleration).
 rpm speed (revolutions per minute).</p> <p>9 Status of speaker
 Speaker switched on.
 Speaker switched off.</p> |
|---|--|

5.2 Menu navigation

Proceed as follows to change settings in the device menu:





1.		Open the menu.
2.		Select the desired menu item.
3.		Confirm your selection.
4.		Select the setting of the corresponding parameters.
5.		Confirm the changed setting. The BACK menu item belonging to the first menu level appears.
6.		Exit the menu.



To exit the second menu level without changing a parameter, select the **BACK** menu item and confirm with **menu/enter**.



5.3 Menu

Tab. 5-1: Menu structure of the Centrifuge 5427 R.

Menu level 1 (M 1)	Menu level 2 (M 2)		Display
<i>SOFT</i> Soft ramp: decreases acceleration speed and braking speed Disabled with short spin centrifugation	<i>On</i>	Rotor accelerates and brakes slowly.	
	<i>OFF</i>	Rotor accelerates and brakes rapidly.	
<i>RAD</i> For the internal conversion of speed (rpm) to <i>g</i> -force (rcf), the radius is dependent on the adapter used.	<i>0_2ML</i> <i>0_4ML</i> <i>0_5ML</i> <i>0_6ML</i> <i>MAX</i>	Select the radius according to the adapter used. Only rotor FA-45-12-17: <i>MAX</i> <i>1_5/2</i> <i>HPLC</i> <i>CRYO</i> Largest radius of the used rotor.	
<i>LOCK</i> Key lock: centrifugation parameters (temperature, <i>g</i> -force (rcf) or speed (rpm)) cannot be accidentally changed.	<i>On</i>	Set the centrifugation parameters permanently. <i>SAFE</i> appears in the display when the time , temp or speed keys are pressed.	
	<i>OFF</i>		
<i>ATSET</i> Set start of centrifuging run time.	<i>On</i>	The set run time will be counted down after 95 % of the specified <i>g</i> -force (rcf) or speed (rpm) has been reached.	
	<i>OFF</i>	The set time is counted down immediately.	

Operation

Centrifuge 5427 R
English (EN)

Menu level 1 (M 1)	Menu level 2 (M 2)		Display
<p><i>SHORT</i> Set the speed of the short spin centrifugation. No SOFT function with short spin centrifugation.</p>	<p><i>MAX</i> <i>Set</i></p>	<p>Short spin centrifugation at the maximum speed of the inserted rotor Short spin centrifugation with set speed (<i>g</i>-force (rcf) or speed (rpm)).</p>	
<p><i>Temp</i> Set the time limit for continuous cooling ("ECO shut-off") (see p. 30).</p>	<p><i>8 h</i> <i>1 h</i> <i>2 h</i> <i>4 h</i> <i>oo</i></p>	<p>Default setting: Continuous cooling ends after 8 h. To limit continuous cooling after a run to 1 h, 2 h, or 4 h, the centrifuge lid must be opened and closed again after the run. Endless operation of continuous cooling.</p>	
<p><i>Alarm</i> Switch the loudspeaker on or off.</p>	<p><i>On</i> <i>OFF</i></p>	<p>Switch on loudspeaker. Switch off loudspeaker.</p>	<p> </p>
<p><i>VOL</i> Set the volume.</p>	<p><i>VOL1</i> ... <i>VOL5</i></p>	<p>The volume of the loudspeaker can be set to 5 levels (<i>VOL1</i> to <i>VOL5</i>). The loudspeaker must be switched on for the adjustment to be audible.</p>	
<p><i>SLEEP</i> Switch the standby mode on or off. If the centrifuge has not been used for 15 min, it will switch to standby. <i>EP</i> then appears in the display. Press a key or close the centrifuge lid to exit the standby mode.</p>	<p><i>On</i> <i>OFF</i></p>	<p>Standby mode activated. Standby mode deactivated.</p>	

The *Back* menu item can also be found in both menu levels.

Back in menu level 2: return to menu level 1.

Back in menu level 1: exit menu.

5.4 Preparing for centrifugation

5.4.1 Switching on the centrifuge

- ▶ Switch the centrifuge on using the mains/power switch.

The centrifuge lid opens automatically after switching on using the mains/power switch.

The parameter settings of the last run are displayed.

5.4.2 Inserting the rotor

1. Fit the rotor vertically on the motor shaft.
2. Insert the supplied rotor key into the rotor nut.
3. Turn rotor key **clockwise** until the rotor nut is firmly tightened.

5.4.3 Automatic rotor detection



The centrifuge has automatic rotor detection. It detects a newly inserted rotor and displays the name of the rotor for 2 s. *g*-force (rcf) and speed (rpm) are automatically limited to the maximum permitted value for the rotor.

- ▶ Manually turn the rotor **counterclockwise** to trigger rotor detection.
 - The name of the rotor appears in the display.
 - The *g*-force (rcf) and speed (rpm) are automatically limited to the maximum permissible value for the rotor.

5.4.4 Replacing the rotor

1. Turn the rotor nut **counterclockwise** using the supplied rotor key.
2. Remove the rotor by lifting it vertically.
3. Vertically place another rotor on the motor shaft.
4. Insert the supplied rotor key into the rotor nut.
5. Turn rotor key **clockwise** until the rotor nut is firmly tightened.
6. In order to trigger the rotor detection, turn the rotor **counterclockwise** by hand.
 - The name of the rotor appears in the display.
 - The *g*-force (rcf) and speed (rpm) are automatically limited to the maximum permissible value for the rotor.



Rotor detection can also be triggered by short spin centrifugation:

- ▶ Press the **short** key until the name of the rotor appears in the display.



Error message after rotor change

- If you start centrifuging immediately after a rotor change, the centrifuge has not carried out an automatic rotor detection yet. The speed set for the previous rotor may exceed the maximum permitted speed for the new rotor. In this case, the centrifuge stops after the automatic rotor detection and displays **SPEED**. The new maximum permitted speed appears in the display. You can then restart the centrifuging with this setting or adjust the speed as necessary.
- ▶ After each rotor change, check whether the new rotor is detected by the device. Check the set *g*-force (rcf) or speed (rpm) and adjust it if necessary.

5.4.5 Loading the rotor

5.4.5.1 Loading a fixed-angle rotor



CAUTION! Risk of injury due to asymmetric loading of a rotor.

- ▶ Load rotors symmetrically with identical tubes.
- ▶ Only load adapters with suitable tubes.
- ▶ Always use the same type of tubes (weight, material/density and volume).
- ▶ Check symmetric loading by balancing the adapters and tubes used with scales.



CAUTION! Risk from damaged or overloaded tubes.

- ▶ When loading the rotor, observe the safety precautions on dangers as a result of overloaded or damaged tubes (see *Warnings for intended use on p. 17*).



Use matching rotor lids

- Fixed-angle rotors may only be operated with the appropriate rotor lid in each case. The rotor name on the rotor must be the same as the name on the rotor lid.
- To carry out an aerosol-tight centrifugation, an aerosol-tight rotor (label: **red ring**) and the corresponding aerosol-tight rotor lid (label: **aerosol-tight** and **red lid screw**) must be used.



The device automatically detects imbalances during operation and stops the run immediately with an error message and a signal tone.

- ▶ Check the load, balance the tubes and restart the run.

To load the rotor, proceed as follows:

1. Check the maximum payload (adapter, tube and contents) for each rotor bore.
The information about this can be found on every rotor and in this operating manual (see *Rotors on p. 9*).
2. Load rotors and adapters only with the tubes intended for them.
3. Insert sets of two tubes in the opposite bores of the rotor. To ensure symmetric loading, tubes that are arranged opposite each other must be of the same type and contain the same filling quantity.

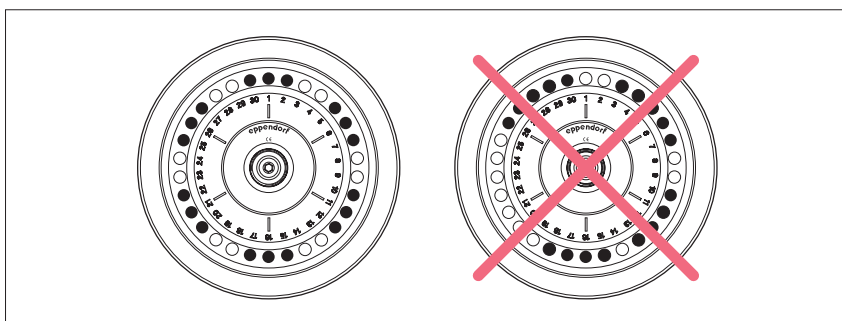

To minimize weight differences between filled sample tubes, we recommend taring with a scale. This will reduce wear on the drive and reduce running noise.



Spin columns

For centrifuging spin columns in the rotor FA-45-24-11-Kit, you can leave the tube lids open. However, this can only be done using the tubes provided by kit manufacturers for this purpose. For reliable centrifugation, you must lean the open tube lids against the edge of the rotor. Ensure that the lids do not protrude past the edge of the rotor in the process, then attach the matching rotor lid.

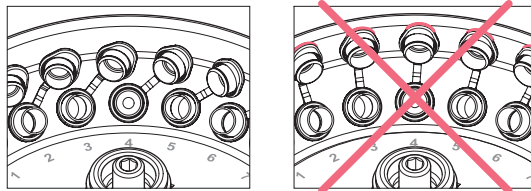

5.4.5.2 Loading a swing-bucket rotor

Prerequisites

- Use a rotor, bucket and adapter combination that is approved by Eppendorf.
- The carriers are sorted by weight category. Carriers located opposite each other must belong to the same weight category. This is laterally engraved in the groove: e.g., 68 (the last two digits in grams). For repeat orders, please specify the weight class.
- Matched and checked tubes

To load the rotor, proceed as follows:

1. Check the bucket grooves for cleanliness and lightly lubricate them with pivot grease (int. order no.: 5810 350.050 / North America: 022634330).
Contaminated grooves and pegs prevent a uniform swinging of the bucket.
2. Hang the buckets into the rotor.
All rotor positions must be loaded with carriers.
3. Check that all carriers are hanging properly and can swing freely.
4. Check the maximum payload (adapter, tube and contents) for each bucket.
The details on the maximum payload can be found on the rotor and in this operating manual (see *Rotors on p. 9*).
5. Load the buckets symmetrically.

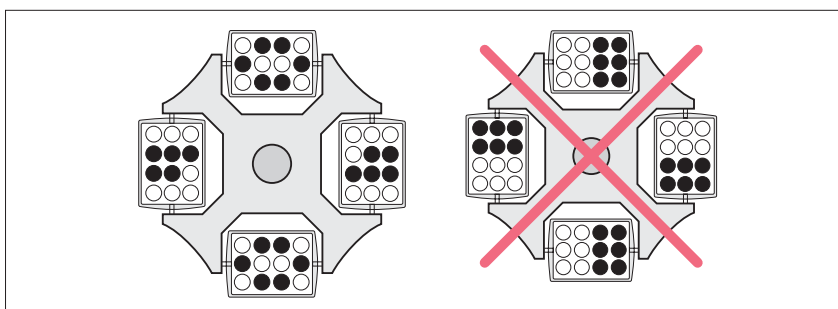

Fig. 5-3: Incomplete, but symmetric loading of the buckets. The pegs of each bucket must be uniformly loaded.

The supply shown on the right side is incorrect because it does not allow the bucket to properly swing out.

Operation

Centrifuge 5427 R
English (EN)

5.4.6 Closing the rotor lid

1. Only QuickLock rotor lid: check that the external sealing ring correctly fits in the groove.
2. Vertically fit the rotor lid on the rotor.
3. Turn the rotor lid screw clockwise to seal the rotor.

Only QuickLock rotor lid:

Turn the rotor lid screw clockwise as far as it will go, until an audible "click" can be heard. The rotor is not properly closed until an audible click is heard!

5.4.7 Closing the centrifuge lid**WARNING! Risk of injury when opening or closing the centrifuge lid.**

There is a risk of crushing your fingers when opening or closing the centrifuge lid.

- ▶ When opening or closing the centrifuge lid, do not reach between the lid and device or into the latching mechanism of the lid.
- ▶ Always open the centrifuge lid completely to prevent it from falling.

1. Check the correct attachment of the rotor and rotor lid.
2. Press the centrifuge lid down until it is gripped by the lid latch.

The lid will be automatically closed and the locking mechanism can be clearly heard.

The **open** key lights up blue. The display shows the ■ symbol.

5.5 Cooling

The centrifuge cools or maintains the set temperature if the following requirements are met:

- The centrifuge is switched on.
- The centrifuge lid is closed.
- Only with continuous cooling: The set temperature is lower than the ambient temperature.



If the rotor stops (continuous cooling), cooling is slower than during centrifugation or a temperature control run.

5.5.1 Set the temperature

1. To set the temperature, use the **temp** arrow keys to select a temperature between -11 °C and 40 °C.
2. Set the run time and *g*-force (rcf) or speed (rpm). Press the **start/stop** key to start the centrifugation.

The temperature can be changed during centrifugation.

5.5.2 Temperature display

Temperature display if the rotor stops

Temperature display during centrifugation

Set temperature

Actual temperature

5.5.3 Temperature monitoring

After the set temperature has been reached, the centrifuge reacts to temperature deviations during centrifugation as follows:

Deviation from target temperature	Action
±3 °C	Temperature display flashes.
±5 °C	Display shows Err 18 . Centrifugation is stopped automatically.

5.5.4 Start FastTemp

With the FastTemp function, you can immediately start a temperature run without samples, at rotor-specific or temperature-specific speeds. This will quickly bring the rotor chamber, including rotor and adapter, up to the set target temperature.

Prerequisites

- The centrifuge is switched on.
- Rotor and rotor lid are correctly mounted.
- The centrifuge lid is closed.
- The temperature and *g*-force (rcf) or speed (rpm) have been set for the upcoming centrifugation (see *Centrifuging on p. 33*).

1. Press the **fast temp** key.

The display shows

- *FT*
- Actual temperature in the rotor chamber
- *g*-force (rcf) or speed (rpm)

The temperature control run FastTemp automatically ends when the target temperature has been reached. A periodic signal tone sounds.

2. Press the **start/stop** key to end the temperature control run early.



- The centrifuge only stops the run once the rotor has reached the set temperature. Therefore, there may be a delay of approx. 15 min (rotor S-24-11-AT: 30 min) between the display indicating the set temperature has been reached and the automatic end of the temperature control run.

5.5.5 Continuous cooling

Continuous cooling

Continuous cooling maintains the rotor chamber at the set temperature if the rotor stops.

- During continuous cooling the display shows the set temperature.
- To prevent the rotor chamber from freezing or condensation from forming, the temperature does not go below 4 °C , irrespective of the set temperature.
- If the rotor stops, temperature control is slower than during centrifugation or a temperature control run.

ECO shut-off

Continuous cooling is switched off if the centrifuge is not used for longer than the preset time. The centrifuge switches to standby mode.

- Default setting: Continuous cooling ends after 8 h.
- Continuous cooling can be limited to 1 h, 2 h or 4 h.
- ECO shut-off can be switched off (continuous cooling set to endless operation).

Limit continuous cooling to 1 h (2 h, 4 h).

1. Press the **menu/enter** key.
2. Select *TEMP* using the arrow key. Confirm with the **menu/enter** key.
3. Select *1 h (2 h, 4 h)* using the arrow key. Confirm with the **menu/enter** key.
4. To activate ECO shut-off after 1 h, 2 h or 4 h, open and close again the centrifuge lid after the end of the run.

The device switches to standby mode after 1 h, 2 h or 4 h. The display shows *EP*.



- If the centrifuge lid is not opened and closed again after the run, ECO shut-off engages after **8 h** (default setting).
- Open the centrifuge lid to end continuous cooling early.

5.5.6 Endless operation of continuous cooling

The ECO shut-off function can be switched off. Continuous cooling is changed to endless operation.

- Endless operation can shorten the service life of the compressor.
- The rotor chamber may freeze.

1. Press the **menu/enter** key.
2. Select *TEMP* using the arrow key. Confirm with the **menu/enter** key.
3. Select *oo* using the arrow key. Confirm with the **menu/enter** key.

Ending continuous cooling

4. Open the centrifuge lid to end continuous cooling.

5.6 Centrifuging



CAUTION! Risk from incorrectly-loaded rotors and damaged/overloaded tubes!

- ▶ Before commencing centrifugation, follow the safety instructions relating to risks from asymmetrically loaded and/or overloaded rotors and from overloaded, damaged and/or open tubes (see *Warnings for intended use on p. 17*).



WARNING! Risk of injury from improperly attached rotors and rotor lids.

- ▶ Only centrifuge with rotor and rotor lid firmly tightened.
- ▶ If unusual noises occur when the centrifuge starts, the rotor or the rotor lid may not be properly secured. Immediately press the **start/stop** key to stop centrifuging.

Before using the Centrifuge 5427 R for the first time, familiarize yourself with the operating controls and the display (see *Overview of operating controls on p. 23*).

Each of the centrifuging variants described here must be preceded by the preparation described above (see *Preparing for centrifugation on p. 27*).

Please also note the instructions on cooling (see p. 30).

5.6.1 Centrifuging with preset time

Perform the following steps in the sequence described.

1. Use **time** to set the run time.
2. Use **temp** to set the temperature.
3. Use **speed** to set the *g*-force (rcf) or speed (rpm).
4. Press **start/stop** to start the centrifugation.

During centrifugation

- ■ blinks in the display when the rotor is running.
- The current actual temperature will be displayed.
- The current *g*-force (rcf) resp. speed (rpm) of the rotor is displayed.
- The **fast temp**, **open**, **short** keys and the device menu are blocked during centrifugation.
- The total run time, temperature and speed (rpm) can be changed during the run. The display can be switched between *g*-force (rcf) and speed (rpm).
- You can also terminate the centrifugation before the set run time has elapsed by pressing the **start/stop** key.

End of centrifugation

- After completion of the set time, the centrifuge stops automatically. During braking the elapsed centrifugation time is displayed flashing. When the rotor stops a signal tone is heard.
- The centrifuge lid remains closed to maintain the sample temperature. You can open it by pressing the **open** key.



During the run you can modify the total run time, the temperature and the *g*-force (rcf)/ speed (rpm).

The values on the display blink while changes are being made. The new parameters are adopted immediately. If the time is changed during a run, the elapsed time will be subtracted from this value. Please note that the shortest new total run time that can be set must be 2 min longer than the elapsed time.



When using adapters, you can adjust the radius.

5.6.2 Centrifuging in continuous operation

Perform the following steps in the sequence described.

1. Use **time** to set the continuous run.
The continuous run function can be set above 9:59 h or below 10 s. The timer shows *oo* to indicate continuous operation.
2. Use **temp** to set the temperature.
3. With **speed**, set the *g*-force (rcf) or speed (rpm).
4. Press the **start/stop** key to start the centrifugation.
The ■ symbol blinks in the display when the rotor is running.
5. Press the **start/stop** key to end the centrifugation.
 - During the braking process, centrifugation time flashes in the display.
 - When the rotor stops a signal tone is heard.
 - The centrifuge lid remains closed to maintain the sample temperature. You can open it by pressing the **open** key.

5.6.3 Short spin centrifugation

Prerequisites

In the *SHORT* menu, the user sets whether the short spin centrifugation runs with the maximum *g*-force (rcf) or speed (rpm) of the inserted rotor (*MAX*) or with a freely selected speed (*SET*).

The short spin centrifugation runs as long as the **short** key is pressed.

1. Only with short spin centrifugation with a set speed: set the *g*-force (rcf) or speed (rpm) using the **speed** arrow keys.
2. Use the **temp** arrow keys to adjust the temperature.
3. Start short spin centrifugation: hold the **short** key pressed down.
 - The ■ symbol blinks in the display when the rotor is running.
 - All other keys are disabled during short spin centrifugation.
4. End short spin centrifugation: release the **short** key.
 - During the braking process, centrifugation time flashes in the display.
 - The centrifuge lid remains closed to maintain the sample temperature. Press the **open** key to open the lid.



During the braking process, the short spin centrifugation can be restarted up to two times by pressing the **short** key again.



The soft ramp is disabled during short spin centrifugation.

5.6.4 Setting the centrifugation radius

If an adapter for tubes is used in a rotor, this changes the centrifugation radius. In the *RAD* menu item, the parameter for the tube/adapter combination has to be set.

Prerequisites

- Rotor is inserted.
- The centrifuge has detected the rotor (see *Automatic rotor detection on p. 27*).

1. Press the **menu/enter** key.
2. Select the *RAD* menu item using the arrow key. Confirm with the **menu/enter** key.
In the *RAD* menu item, the parameters for the rotor-specific tube/adapter combination are available.
3. Select the parameters for the tube/adapter combination using the arrow key. Confirm with the **menu/enter** key.

The display shows the *g*-force for the rotor/adapter combination used in the rotor.



Default setting: If the centrifugation speed is only controlled using the *g*-force (rcf), the centrifuge calculates the *g*-force for the largest radius of the rotor used.

5.6.5 After centrifugation



If start centrifuging immediately has not been used for 15 min, it switches to standby. *EP* appears in the display.

If the centrifuge is temporarily not used, carry out the following steps. Please also observe the care instructions (see p. 39).

- ▶ Turn the rotor nut **counterclockwise** using the supplied rotor key.
Remove the rotor by lifting it vertically.
- ▶ Empty the condensation water tray.
- ▶ Leave the centrifuge lid open.

5.7 Standby mode

The centrifuge switches to the standby mode when the following prerequisites are met:

- Centrifuge lid is open: centrifuge has not been used for 15 min.
- The centrifuge lid is closed: continuous cooling was stopped (see *Continuous cooling on p. 32*).

In the **Standby mode**, the following applies :

- The display shows *EP*.
- The rotor chamber is not cooled .
- ▶ Press any key to end the standby mode.

6 Maintenance

6.1 Prepare cleaning/disinfection

- ▶ Clean all accessible surfaces of the device and the accessories at least weekly and when contaminated.
- ▶ Clean the rotor regularly. This way the rotor is protected and the durability is prolonged.
- ▶ Furthermore, observe the notes on decontamination (see *Decontamination before shipment on p. 40*) when the device is sent to the authorized Technical Service for repairs.

The procedure described in the following chapter applies to the cleaning as well as to the disinfection or decontamination. The table below describes the steps required on top of this:

Cleaning	Disinfecting/decontamination
<ol style="list-style-type: none"> 1. Use a mild cleaning fluid to clean the accessible surfaces of the device and the accessories. 2. Carry out the cleaning as described in the following chapter. 	<ol style="list-style-type: none"> 1. Choose the disinfection method which corresponds to the legal regulations and guidelines in place for your range of application. For example, use alcohol (ethanol, isopropanol) or alcohol-based disinfectants. 2. Carry out the disinfection or decontamination as described in the following chapter. 3. Then clean the device and the accessories.



If you have any further questions regarding the cleaning and disinfection or decontamination or regarding the cleaning fluid to be used, contact the Eppendorf AG Application Support. The contact details are provided on the back of this manual.

6.2 Cleaning/disinfection



DANGER! Electric shock as a result of penetration of liquid.

- ▶ Switch off the device and disconnect the power plug before starting cleaning or disinfection work.
- ▶ Do not allow any liquids to penetrate the inside of the housing.
- ▶ Do not spray clean/spray disinfect the housing.
- ▶ Only plug the device back in if it is completely dry, both inside and outside.



NOTICE! Damage from the use of aggressive chemicals.

- ▶ Do not use any aggressive chemicals on the device or its accessories, such as strong and weak bases, strong acids, acetone, formaldehyde, halogenated hydrocarbons or phenol.
- ▶ If the device has been contaminated by aggressive chemicals, clean it immediately using a mild cleaning agent.



NOTICE! Corrosion due to aggressive cleaning agents and disinfectants.

- ▶ Do not use corrosive cleaning agents, aggressive solvents or abrasive polishes.
- ▶ Do not incubate the accessories in aggressive cleaning agents or disinfectants for longer periods.



NOTICE! Damage from UV and other high-energy radiation.

- ▶ Do not use UV, beta, gamma, or any other high-energy radiation for disinfecting.
- ▶ Avoid storage in areas with strong UV radiation



Autoclaving

All rotors, rotor lids and adapters can be autoclaved (121 °C, 20 min).



Aerosol tightness

Check that the seals are intact before use.

Only QuickLock rotor lid: Replace the sealing ring in the lid groove when it becomes worn.

The sealing rings require regular care to protect the rotors.

Aerosol-tight rotors should never be stored with lids screwed on!

In order to prevent damage, lightly lubricate the lid thread of the aerosol-tight rotors with pivot grease (order no. Int.: 5810 350.050/North America: 022634330).

6.2.1 Cleaning and disinfecting the device

1. Open the lid. Switch off the device with the mains/power switch. Disconnect the power plug from the power supply.
2. Loosen the rotor nut by turning the rotor key **counterclockwise**.
3. Remove the rotor.
4. Clean and disinfect all accessible surfaces of the device, including the power cable, using a damp cloth and the recommended cleaning agents.
5. Thoroughly clean the rubber seals of the rotor chamber with water.
6. Rub the dry rubber seals with glycerine or talcum powder to prevent them from becoming brittle. Other components of the device, such as the lid latch, motor shaft and rotor cone, must not be lubricated.
7. Clean the motor shaft with a soft, dry and lint-free cloth. Do not lubricate the motor shaft.
8. Check the motor shaft for damage.
9. Inspect the device for corrosion and damage.
10. Leave the centrifuge lid open when the device is not being used.
11. Only connect the device to the power supply if it is fully dry inside and out.

6.2.2 Cleaning and disinfecting the rotor

1. Inspect the rotor and accessories for damage and corrosion. Do not use any damaged rotors or accessories.
2. Clean and disinfect the rotors and accessories with the recommended cleaning agents.
3. Clean and disinfect the rotor lids. **ONLY QuickLock:** It is imperative that the sealing ring be removed during this process so that the groove below it can be thoroughly cleaned.

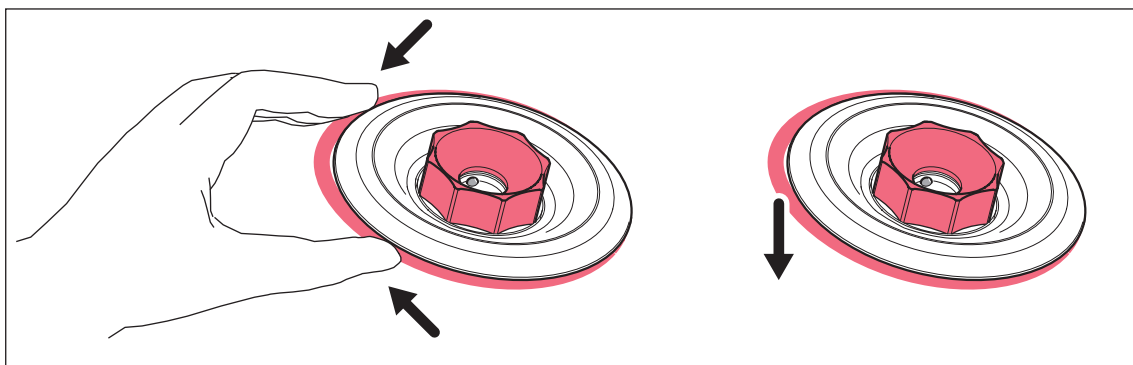

4. Rinse the rotors and accessories thoroughly with distilled water. Rinse the rotor bores of fixed-angle rotors particularly thoroughly.



Do not immerse the rotor in liquid as liquid can get trapped inside the cavities.

5. Place rotors and accessories on a cloth to dry. Place fixed-angle rotors with the rotor bores facing downwards to allow the bores to also dry.
6. Correctly reinsert the rotor lid sealing ring in the clean and dry groove.
7. Clean the rotor cone with a soft, dry and lint-free cloth. Do not lubricate the rotor cone.
8. Inspect the rotor cone for damage.
9. Place the dry rotor onto the motor shaft.
10. Tighten the rotor nut firmly by turning it **clockwise** with the rotor key.
11. Leave the rotor lid open when the rotor is not being used.

6.3 Additional service instructions for Centrifuge 5427 R

- ▶ Empty and clean the condensation water tray regularly and especially after liquid spillage in the rotor chamber.
- ▶ Regularly free the rotor chamber ice formations via thawing, by leaving the centrifuge lid open or carrying out a short temperature control run at approx. 30 °C.
- ▶ Leave the centrifuge lid open when not in use for a long period.
Residual moisture can escape. The lid spring is relieved.
- ▶ Wipe up condensate in the rotor chamber using a soft, absorbent cloth.
- ▶ Remove dust deposits from the ventilation slits of the centrifuge using a brush or swab at the latest every six months. First switch off the device and remove the power plug.

6.4 Glass breakage

When using glass tubes there is a risk of glass breakage in the rotor chamber. The resulting glass splinters are swirled around in the rotor chamber during centrifugation and have a sandblasting effect on the rotor and accessories. The smallest glass particles become lodged in the rubber parts (e.g., the motor guide, the rotor chamber seal, and the rubber mats of adapters).



NOTICE! Glass breakage in the rotor chamber

Glass tubes in the rotor chamber may break if the *g*-force is too high. Broken glass can damage the rotor, accessories and samples.

- ▶ Please note the manufacturer's information on the recommended centrifugation parameters (load and speed).

Effects of glass breakage in the rotor chamber:

- Fine black metal abrasion in the rotor chamber (in metal rotor chambers)
- The surfaces of the rotor chamber and accessories are scratched.
- The chemical resistance of the rotor chamber is reduced.
- Contamination of samples
- Wear on rubber parts

How to proceed in case of glass breakage

1. Remove all splinters and glass powder from the rotor chamber and accessories.
2. Thoroughly clean the rotor and rotor chamber. Thoroughly clean the bores of the fixed-angle rotors, in particular.
3. If required, replace the adapters to prevent any further damage.
4. Regularly check the rotor bores for deposits and damage.

6.5 Replacing fuses



DANGER! Electric shock.

- ▶ Switch off the device and disconnect the power plug before starting maintenance or cleaning work.

The fuse holder is located between the mains connection socket and the mains power switch.

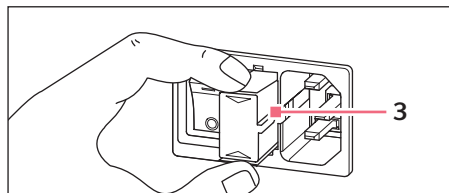
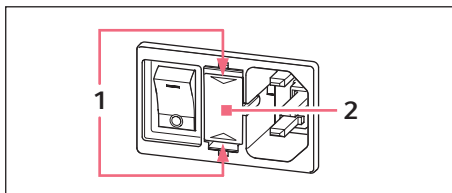

1. Disconnect the power plug.
2. Press the upper and lower end of the plastic springs **1** together and pull the fuse holder **2** fully out.
3. Replace faulty fuses and reinsert the fuse holder. Make sure that the guiding rail **3** is positioned correctly.

6.6 Decontamination before shipment

If you are shipping the device to the authorized Technical Service for repairs or to your authorized dealer for disposal please note the following:



WARNING! Risk to health from contaminated device

1. Follow the instructions in the decontamination certificate. It is available as a PDF file on our webpage (www.eppendorf.com/decontamination).
2. Decontaminate all the parts you would like to dispatch.
3. Include the fully completed decontamination certificate in the package.

7 Troubleshooting

If you cannot remedy an error with the recommended measures, please contact your local Eppendorf partner. The contact address can be found online at: www.eppendorf.com.

7.1 General errors

Symptom/message	Cause	Remedy
No display.	No mains power connection.	▶ Check the mains power connection.
No display.	Power failure.	▶ Check the mains fuse of the laboratory.
Lid of the device cannot be opened.	Rotor is still running.	▶ Wait for rotor to stop.
Lid of the device cannot be opened.	Power failure.	1. Check the mains fuse of the laboratory.
Device cannot be started.	Lid of the device is not closed.	▶ Close the lid of the device.
Device shakes when it starts up.	Rotor is asymmetrically loaded.	1. Stop the device and load symmetrically. 2. Reboot device.
Centrifuge brakes during a short run centrifugation, although the short key is pressed.	The short key was released briefly more than twice (protective function for the drive).	▶ Press the short key continuously during a short run centrifugation.
Temperature display flashes.	Temperature deviation from the set value: ± 3 °C.	▶ Check the settings. ▶ Wait until the target temperature has been reached. ▶ Check unhindered air circulation through the air slots. ▶ Thaw ice or switch off device and allow it to cool down.

7.2 Error messages

Proceed as follows if the following error messages appear:

1. Remove fault (see remedy).
2. If necessary, repeat centrifugation.

Symptom/message	Cause	Remedy
<i>ERR 1</i>	Rotor not detected.	<ul style="list-style-type: none"> ▶ Check rotor. ▶ If this error message appears again, test with a different rotor.
<i>Err 2</i>	Electronics fault.	<ul style="list-style-type: none"> ▶ Switch centrifuge off and back on again after > 20 s.
<i>NO RPM (ERR 3)</i>	Error in speed measuring system.	<ul style="list-style-type: none"> ▶ Leave the device switched on until the error message disappears (10 s or 6 min).
<i>Err 5</i>	Prohibited opening of lid or lid switch is defective during a run.	<ul style="list-style-type: none"> ▶ Wait for rotor to stop.
<i>Err 6</i>	<ul style="list-style-type: none"> • Error in the drive electronics. • Drive overheated. 	<ul style="list-style-type: none"> ▶ Repeat the run. ▶ If this error message appears again, switch centrifuge off and back on again after > 20 s. ▶ Allow the drive to cool down for at least 15 min.
<i>Err 7</i>	Major deviation in the speed control.	<ol style="list-style-type: none"> 1. Wait for rotor to stop. 2. Tighten the rotor.
<i>Err 8</i>	Drive fault.	<ol style="list-style-type: none"> 1. Wait for rotor to stop. 2. Repeat the run.
<i>ERR 9 to ERR 14</i>	Electronics error.	<ul style="list-style-type: none"> ▶ Switch centrifuge off and back on again after > 20 s.
<i>IMBAL (ERR 15)</i>	Rotor is asymmetrically loaded.	<ul style="list-style-type: none"> ▶ Load the rotor symmetrically and balance.
<i>ERR 16 to ERR 17</i>	Electronics error.	<ul style="list-style-type: none"> ▶ Switch centrifuge off and back on again after > 20 s.
<i>Err 18</i>	Temperature deviation from set value in the rotor chamber: ± 5 °C.	<ul style="list-style-type: none"> ▶ Check the settings. ▶ Check unhindered air circulation through the air slots. ▶ Thaw ice or switch off device and allow it to cool down.
<i>Err 19</i>	Condenser overheated.	<ul style="list-style-type: none"> ▶ Check unhindered air circulation through the air slots. ▶ Allow device to cool down.
<i>Err 20</i>	Temperature sensor in rotor chamber is faulty.	<ul style="list-style-type: none"> ▶ Switch centrifuge off and back on again after > 20 s.
<i>Err 21</i>	Temperature sensor on condenser is faulty.	<ul style="list-style-type: none"> ▶ Switch centrifuge off and back on again after > 20 s.

Symptom/message	Cause	Remedy
<i>Err 22</i>	Electronics fault.	▶ Switch centrifuge off and back on again after > 20 s.
<i>NO E-FAN (ERR 23)</i>	Electronic fan is faulty.	▶ Switch centrifuge off and back on again after > 20 s.
<i>Err 24</i>	Failure at the compressor.	▶ Allow the centrifuge to cool down and repeat the run.
<i>INT (ERR 25)</i>	Power failure during a run.	▶ Check the mains connection.
<i>Err 28</i>	Error during speed check.	▶ Switch centrifuge off and back on again after > 20 s.
<i>Err 29</i>	Set g-force/speed too high, e.g. after a rotor change (see <i>Automatic rotor detection on p. 27</i>).	▶ Check the g-force/speed. ▶ Repeat the run.
<i>LID (ERR 30)</i>	<ul style="list-style-type: none"> • Centrifuge lid cannot be locked. • Centrifuge lid cannot be released. 	▶ Try again to close centrifuge lid. ▶ Switch the centrifuge off and back on. ▶ Press the open key. If the error occurs repeatedly: ▶ Switch off centrifuge. ▶ Actuate emergency release(see <i>Emergency release on p. 44</i>).
<i>OFF</i>	<ul style="list-style-type: none"> • Displayed after power off. 	

7.3 Emergency release

If the centrifuge lid cannot be opened, you can activate the emergency release manually.



WARNING! Risk of injury from rotating rotor.

If the emergency release of the lid is operated, the rotor may continue rotating for several minutes.

- ▶ Wait until the rotor stop before operating the emergency release.
 - ▶ Check the monitoring glass in the centrifuge lid.
-



Use the rotor key delivered with the Centrifuge 5427 R for the emergency release.

1. Pull the mains/power plug.
2. Remove the plastic cover for the emergency release on the right side of the device (see Fig. 1 and Fig. 2).
Turn the plastic cover 90° **counterclockwise** using an appropriate tool (e.g., screwdriver) and remove it.
3. Insert the centrifuge rotor key in the rear hexagonal opening until a noticeable resistance is felt.
4. Turn the rotor key **counterclockwise**.
This will release the centrifuge lid.
5. Open the centrifuge lid.
6. Remove the rotor key or turn the plastic covers back on.
Turn the plastic cover using an appropriate tool (e.g., screwdriver) by 90° in a **clockwise** direction.

8 Transport, storage and disposal

8.1 Transport



CAUTION! Risk of injury due to lifting and carrying heavy loads

The device is heavy. Lifting and carrying the device can lead to back injuries.

- ▶ Transport and lift the device with an adequate number of helpers only.
- ▶ Use a transport aid to transport the device.

- ▶ Remove the rotor from the centrifuge before transport.
- ▶ Use the original packaging and the transport securing devices for transport.

	Air temperature	Relative humidity	Atmospheric pressure
General transport	-25 °C – 60 °C	10 % – 75 %	30 kPa – 106 kPa
Air freight	-20 °C – 55 °C	10 % – 75 %	30 kPa – 106 kPa

8.2 Storage

	Air temperature	Relative humidity	Atmospheric pressure
In transport packaging	-25 °C – 55 °C	10 % – 75 %	70 kPa – 106 kPa
Without transport packaging	-5 °C – 45 °C	10 % – 75 %	70 kPa – 106 kPa

8.3 Disposal

In case the product is to be disposed of, the relevant legal regulations are to be observed.

Information on the disposal of electrical and electronic devices in the European Community:

Within the European Community, the disposal of electrical devices is regulated by national regulations based on EU Directive 2002/96/EC pertaining to waste electrical and electronic equipment (WEEE).

According to these regulations, any devices supplied after August 13, 2005, in the business-to-business sphere, to which this product is assigned, may no longer be disposed of in municipal or domestic waste. To document this, they have been marked with the following identification:



Because disposal regulations may differ from one country to another within the EU, please contact your supplier if necessary.

Transport, storage and disposal

Centrifuge 5427 R

English (EN)

9 Technical data

9.1 Power supply

Centrifuge 5427 R

Mains connection	230 V, 50 Hz – 60 Hz 120 V, 50 Hz – 60 Hz 100 V, 50 Hz – 60 Hz
Current consumption	2.4 A (230 V) 4.6 A (120 V) 5.5 A (100 V)
Power consumption	Maximum 550 W
EMC: interference emission (radio interference)	EN 61326 – Class B (230 V) FCC15 - Class A (120 V/100 V)
EMC: noise immunity	EN 61326
Overvoltage category	II
Fuses	4 A (230 V) 8 A (120 V) 10 A (100 V)
Degree of pollution	2

9.2 Ambient conditions

Ambience	Only for use indoors.
Ambient temperature	10 °C – 40 °C
Relative humidity	10 % – 75 %, non-condensing.
Atmospheric pressure	79.5 kPa – 106 kPa

9.3 Weight/dimensions

Dimensions	Width: 31.9 cm (12.6 in) Depth: 54.0 cm (21.3 in) Height: 25.4 cm (10.2 in)
Weight without rotor	30.0 kg (66.14 lb)
Noise level	< 56 dB(A)*

* The noise level was measured head-on, according to DIN EN ISO 3745, in an acoustic chamber with accuracy class 1, at a distance of 1 m to the device and at the height of the lab bench.

9.4 Application parameters

Run time	10 s – 9:59 h, infinite (∞), <ul style="list-style-type: none"> • 10 s – 2 min: can be set in increments of 10 s • 2 min – 10 min: can be set in increments of 30 s • 10 min – 9:59 h: can be set in increments of 1 min
Temperature	-11 °C – 40 °C
Relative centrifugal force	$1 \times g$ – $25\,001 \times g$ can be set in increments of $50 \times g$
Speed	100 rpm – 16 220 rpm can be set in increments of 50 rpm
Maximum load	48 tube with 2.0 mL volume
Maximum kinetic energy	9920 Nm
Compulsory test log book (in Germany)	No
Permissible density of the material for centrifuging (at maximum g -force (rcf) or speed (rpm) and maximum load)	1.2 g/mL

9.5 Acceleration times and deceleration times for the Centrifuge 5427 R (according to DIN 58 970)

Rotor	Acceleration time/Deceleration time		Mains voltage		
			230 V	120 V	100 V
FA-45-12-17	Without soft ramp	Acceleration time	27 s	29 s	29 s
		Deceleration time	24 s	25 s	25 s
	With soft ramp	Acceleration time	39 s	39 s	39 s
		Deceleration time	39 s	39 s	39 s
FA-45-24-11	Without soft ramp	Acceleration time	18 s	19 s	19 s
		Deceleration time	18 s	19 s	19 s
	With soft ramp	Acceleration time	29 s	29 s	29 s
		Deceleration time	31 s	31 s	31 s
FA-45-24-11-Kit	Without soft ramp	Acceleration time	21 s	22 s	22 s
		Deceleration time	21 s	21 s	21 s
	With soft ramp	Acceleration time	32 s	32 s	32 s
		Deceleration time	31 s	31 s	31 s
FA-45-30-11	Without soft ramp	Acceleration time	21 s	22 s	22 s
		Deceleration time	18 s	19 s	19 s
	With soft ramp	Acceleration time	32 s	32 s	32 s
		Deceleration time	33 s	33 s	33 s
F-45-30-11	Without soft ramp	Acceleration time	21 s	22 s	22 s
		Deceleration time	18 s	19 s	19 s
	With soft ramp	Acceleration time	29 s	29 s	31 s
		Deceleration time	32 s	32 s	32 s
FA-45-48-11	Without soft ramp	Acceleration time	28 s	29 s	29 s
		Deceleration time	22 s	23 s	23 s
	With soft ramp	Acceleration time	36 s	36 s	39 s
		Deceleration time	35 s	35 s	35 s
F-45-48-11	Without soft ramp	Acceleration time	28 s	29 s	29 s
		Deceleration time	22 s	23 s	23 s
	With soft ramp	Acceleration time	36 s	36 s	36 s
		Deceleration time	35 s	35 s	35 s
F-45-48-PCR	Without soft ramp	Acceleration time	11 s	12 s	12 s
		Deceleration time	12 s	13 s	13 s
	With soft ramp	Acceleration time	22 s	22 s	22 s
		Deceleration time	22 s	22 s	22 s
S-24-11-AT	Without soft ramp	Acceleration time	18 s	18 s	18 s
		Deceleration time	17 s	17 s	17 s
	With soft ramp	Acceleration time	29 s	29 s	29 s
		Deceleration time	30 s	30 s	30 s

10 Ordering Information

10.1 Centrifuge 5427 R

Order no. (International)	Order no. (North America)	Description
5409 000.012 5409 000.136 5409 000.039	5409000136	Centrifuge 5427 R without rotor 230 V, 50 Hz – 60 Hz 120 V, 50 Hz – 60 Hz 100 V, 50 Hz – 60 Hz

10.2 Accessories

10.2.1 Rotors and rotor lids

Order no. (International)	Order no. (North America)	Description
5409 702.009	5409702009	Rotor FA-45-24-11 aerosol-tight, aluminum, angle 45°, 24 places, max. tube diameter 11 mm, incl. rotor lid (aluminum)
5409 703.005	5409703005	Rotor lid for F-45-24-11 aerosol-tight, aluminum
5409 717.006	5409717006	Seal for rotor lid FA-45-24-11 (5427 R), FA-45-16-17 (5430/5430 R) Set of 5 pieces
5409 706.004	5409706004	Rotor FA-45-30-11 aerosol-tight, aluminum, angle 45°, 30 places, max. tube diameter 11 mm, incl. rotor lid (aluminum)
5409 707.000	5409707000	Rotor lid for FA-45-30-11 aerosol-tight, aluminum
5820 762.004	5820762004	Seal for rotor lid FA-45-30-11 (5427 R/5430/5430 R) Set of 5 pieces
5409 708.007	5409708007	Rotor F-45-30-11 aluminum, angle 45°, 30 places, max. tube diameter 11 mm, incl. rotor lid (polypropylene)
5409 709.003	5409709003	Rotor lid for F-45-30-11 Polypropylene
5409 710.001	5409710001	Rotor FA-45-48-11 aerosol-tight, aluminum, angle 45°, 48 places, max. tube diameter 11 mm, incl. rotor lid (aluminum)
5409 711.008	5409711008	Rotor lid for FA-45-48-11 aerosol-tight, aluminum
5409 718.002	5409718002	Seal for rotor lid FA-45-48-11 (5427 R/5430/5430 R) set of 5 pieces
5409 712.004	5409712004	Rotor F-45-48-11 aluminum, angle 45°, 48 places, max. tube diameter 11 mm, incl. rotor lid (polypropylene)

Ordering Information

Centrifuge 5427 R
English (EN)

Order no. (International)	Order no. (North America)	Description
5409 713.000	5409713000	Rotor lid for F-45-48-11 Polypropylene
5409 704.001	5409704001	Rotor FA-45-24-11-Kit aerosol-tight, aluminum, angle 45°, 24 places, max. tube diameter 11 mm, incl. rotor lid
5409 705.008	5409705008	Rotor lid for FA-45-24-11-Kit aerosol-tight, aluminum
5820 767.006	5820767006	Seal for rotor lid FA-45-24-11-Kit (5427 R/5430/5430 R), FA-45-48-11, FA-45-20-17 (5804/5804 R/5810/5810 R) Set of 5 pieces
5409 700.006	5409700006	Rotor FA-45-12-17 aerosol-tight, aluminum, 45° angle, 12 places, max. tube diameter 17 mm, incl. rotor lid (aluminum)
5409 701.002	5409701002	Rotor lid for FA-45-12-17 aerosol-tight, aluminum
5409 716.000	5409716000	Seal for rotor lid FA-45-12-17 (5427 R) set of 5 pieces
5409 714.007	5409714007	Rotor F-45-48-5-PCR aluminum, angle 45°, 48 places, max. tube diameter 6 mm
5409 715.003	5409715003	Rotor S-24-11-AT aerosol-tight, steel, angle 90°, 24 places, max. tube diameter 11 mm, incl. rotor lid (aluminum)
5409 720.007	5409720007	Rotor lid for S-24-11-AT aerosol-tight, aluminum
5409 721.003	5409721003	Tube holder for S-24-11-AT for 4 × 1,5 mL/2,0 mL Eppendorf tubes set of 2 pieces
5409 719.009	5409719009	Seal for rotor lid S-24-11-AT (5427 R/5430/5430 R) set of 5 pieces

Aerosol impermeability tested and certified by the Centre of Emergency Preparedness and Response, Health Protection Agency, Porton Down (UK).

10.2.2 Adapters

Order no. (International)	Order no. (North America)	Description
5425 715.005 5425 717.008 5425 716.001	022636260 022636243 022636227	Adapter used in FA-45-48-11, F-45-48-11, FA-45-30-11, F-45-30-11, FA-45-24-11, FA-45-24-11-Kit for 1 PCR tube (0.2 mL, max. Ø 6 mm), set of 6 for 1 sample tube (0.4 mL, max. Ø 6 mm), set of 6 pieces for 1 sample tube (0.5 mL, max. Ø 6 mm) or 1 Microtainer (0.6 mL, max. Ø 8 mm), set of 6

10.2.3 Other accessories

Order no. (International)	Order no. (North America)	Description
5416 301.001	022634305	Rotor key Standard
5409 850.083		Tray for condensation water

10.3 Safety

Order no. (International)	Order no. (North America)	Description
5301 850.249	022654403	Fuse 4.0 A (230 V), 2 pieces
5427 850.341	022654381	8.0 AT UL (120 V), 2 pieces
5811 352.006	022664107	10.0 AT UL (100 V), 2 pieces

Ordering Information

Centrifuge 5427 R
English (EN)

EG-Konformitätserklärung EC Conformity Declaration

Das bezeichnete Produkt entspricht den einschlägigen grundlegenden Anforderungen der aufgeführten EG-Richtlinien und Normen. Bei einer nicht mit uns abgestimmten Änderung des Produktes oder einer nicht bestimmungsgemäßen Anwendung verliert diese Erklärung ihre Gültigkeit.

The product named below fulfills the relevant fundamental requirements of the EC directives and standards listed. In the case of unauthorized modifications to the product or an unintended use this declaration becomes invalid.

Produktbezeichnung, Product name:

Centrifuge 5427 R

einschließlich Zubehör / including accessories

Produkttyp, Product type:

Laborzentrifuge / Laboratory Centrifuge

Einschlägige EG-Richtlinien/Normen, Relevant EC directives/standards:

2006/95/EG, EN 61010-1, EN 61010-2-20, 97/23/EG, EN 378-2

2004/108/EG, EN 55011/B, EN 61000-3-2, EN 61000-3-3, EN 61326-1, 2011/65/EU

98/79/EG, EN 14971, EN 61010-2-101, EN 62366, EN 18113-3



Vorstand, Board of Management

25.05.2012

Hamburg, Date



Projektmanagement, Project Management

eppendorf



Eppendorf AG | Barkhausenweg 1 | 22330 Hamburg | Germany



Certificate of Containment Testing

Containment Testing of Rotor FA-45-48-11 (5409 710.109-00) in the Eppendorf 5427/R Bench Top Centrifuge

Report No. 200-12 A

Report Prepared For: Eppendorf AG, Hamburg, Germany

Issue Date: 12th September 2012

Test Summary

Rotor FA-45-48-11 (5409 710.109-00) was containment tested in the Eppendorf 5427/R bench top centrifuge, using Annex AA of IEC 1010-2-20. The sealed rotor was shown to contain a spill within the centrifuge

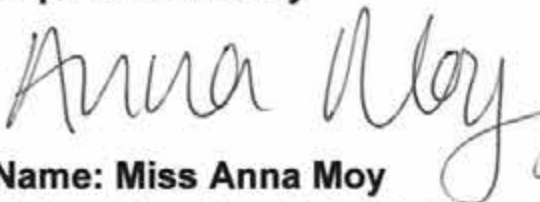
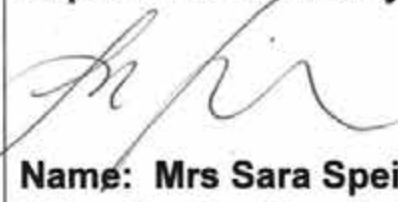
Report Written By  Name: Miss Anna Moy Title: Biosafety Scientist	Report Authorised By  Name: Mrs Sara Speight Title: Senior Biosafety Scientist
--	--



Certificate of Containment Testing

Containment Testing of Rotor FA-45-30-11 (5409 706.101-00) in the Eppendorf 5427/R Bench Top Centrifuge

Report No. 200-12 B

Report Prepared For: Eppendorf AG, Hamburg, Germany

Issue Date: 12th September 2012

Test Summary

Rotor FA-45-30-11 (5409 706.101-00) was containment tested in the Eppendorf 5427/R bench top centrifuge, using Annex AA of IEC 1010-2-20. The sealed rotor was shown to contain a spill within the centrifuge

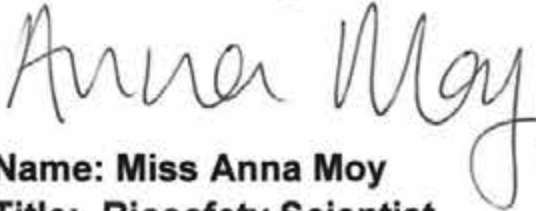
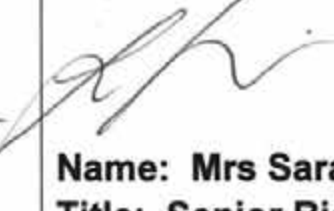
Report Written By  Name: Miss Anna Moy Title: Biosafety Scientist	Report Authorised By  Name: Mrs Sara Speight Title: Senior Biosafety Scientist
--	--



Certificate of Containment Testing

Containment Testing of Rotor FA-45-24-11 (5409 702.106-00) in the Eppendorf 5427/R Bench Top Centrifuge

Report No. 200-12 D

Report Prepared For: Eppendorf AG, Hamburg, Germany

Issue Date: 12th September 2012

Test Summary

Rotor FA-45-24-11 (5409 702.10-00) was containment tested in the Eppendorf 5427/R bench top centrifuge, using Annex AA of IEC 1010-2-20. The sealed rotor was shown to contain a spill within the centrifuge

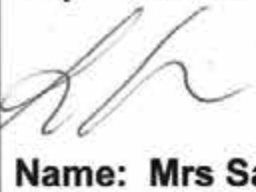
Report Written By  Name: Miss Anna Moy Title: Biosafety Scientist	Report Authorised By  Name: Mrs Sara Speight Title: Senior Biosafety Scientist
--	--



Certificate of Containment Testing

Containment Testing of Rotor FA-45-24-11-Kit (5409 704.109-00) in the Eppendorf 5427/R Bench Top Centrifuge



Report No. 200-12 E

Report Prepared For: Eppendorf AG, Hamburg, Germany

Issue Date: 12th September 2012

Test Summary

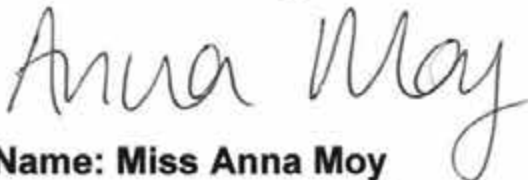
Rotor FA-45-24-11-Kit (5409 704.109-00) was containment tested in the Eppendorf 5427/R bench top centrifuge, using Annex AA of IEC 1010-2-20. The sealed rotor was shown to contain a spill within the centrifuge

Report Written By  Name: Miss Anna Moy Title: Biosafety Scientist	Report Authorised By  Name: Mrs Sara Speight Title: Senior Biosafety Scientist
--	--



Certificate of Containment Testing

Containment Testing of Rotor FA-45-12-17 (5409 700.103-00) in the Eppendorf 5427/R Bench Top Centrifuge

Report No. 38/13

Report Prepared For: Eppendorf AG, Hamburg, Germany

Issue Date: 24th April 2013

Test Summary

Rotor FA-45-12-17 (5409 700.103-00) was containment tested in the Eppendorf 5427/R bench top centrifuge, using Annex AA of IEC 61010-2-020:2006 (2nd Ed.). The sealed rotor was shown to contain a spill within the centrifuge.

Report Written By

Name: Miss Anna Moy

Title: Biosafety Scientist

Report Authorised By

Name: Mrs Sara Speight

Title: Senior Biosafety Scientist



Certificate of Containment Testing

Containment Testing of Rotor S-24-11-AT (5409 715.100-00) in the Eppendorf 5427/R Bench Top Centrifuge

Report No. 200-12 F

Report Prepared For: Eppendorf AG, Hamburg, Germany

Issue Date: 12th September 2012

Test Summary

Rotor S-24-11-AT (5409 715.100-00) was containment tested in the Eppendorf 5427/R bench top centrifuge, using Annex AA of IEC 1010-2-20. The sealed rotor was shown to contain a spill within the centrifuge

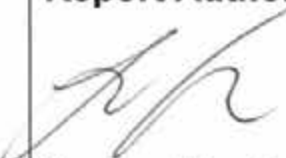
Report Written By  Name: Miss Anna Moy Title: Biosafety Scientist	Report Authorised By  Name: Mrs Sara Speight Title: Senior Biosafety Scientist
--	--

Evaluate your manual

Give us your feedback.
www.eppendorf.com/manualfeedback